

TRIO Cast Iron Boiler



CAST IRON BOILERS

Features

- 3-Pass wet base Euro design
- Energy Star rated for high efficiency to 87%
- Multi-fuel (oil or gas)
- Low mass, low water content
- Lightweight: Small footprint
- Direct vent capability, no chimney needed (P3~P5)
- Available burners: Beckett AFG and NX; Riello F5 and BF5; Carlin EZ; and Carlin EZ Gas
- Quick-disconnects on all burner harnesses
- Total Access: Full-swing left or right hinged door for complete accessibility
- Fuel Smart Hydrostat® 3250 control
 - Temperature Limit Control: Designed for cold start boilers
 - Low Water Cut-Off: Provides protection against potentially dangerous low water conditions
 - Boiler Reset Control: Utilizes Thermal Targeting™ technology to conserve fuel by monitoring heating demand and establishing target boiler temperatures below the high limit setting
- Remote sensor and immersion well
- ASME safety relief valve
- Strongbox crating system
- Limited lifetime warranty

The TRIO® boiler by PurePro® combines high efficiencies, convenient serviceability, and low mass European 3-Pass Technology.

It is constructed of GG20-rated cast iron for Thermal Shock Protection and durability.

The TRIO boiler's state-of-the-art design includes recirculating flue gas technology for reduced emissions.

The TRIO boiler comes standard with a Hydrolevel 3250 Hydrostat, which combines Temperature Limit Control, LWCO and Boiler Reset in one easy-to-use control.

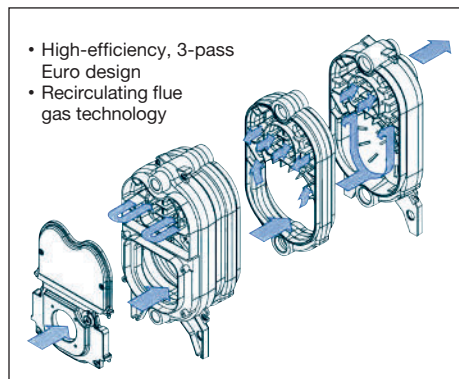

Shown with
Riello F5 Oil Burner
with optional stand and
Energy Manager Plus II



PurePro Energy Manager Plus II

The optional PurePro Energy Manager Plus II integrates a five-zone relay board, boiler aquastat, low water cutoff, and boiler reset. This simple-to-use control comes completely pre-wired.

The PurePro Energy Manager Plus II features the Honeywell AQ25042B multiple zone control and the Hydrolevel 3250 HydroStat. The HydroStat 3250 uses Thermal Targeting to match the heat load and boiler water temperature.

To further enhance fuel efficiency, the fuel smart HydroStat is also equipped with a thermal pre-purge feature. When activated, the control will purge standing heat in the boiler at the start of any thermostat call, supplying the free latent energy to the heating zone that is calling.

FuelSmart
HydroStat 3250



Boiler Mount

Specifications

PurePro Boiler Model #	Firing Rate (#2 Fuel)	PurePro Burner Model #	Burner	Nozzle	Input (BTU/hr)	DOE Capacity (BTU/hr)	NET IBR (BTU/hr)	Net Rating (Sq. ft.)	AFUE Rating	Water Capacity	Shipping Weight
PROP3	0.75	707719 707724 707740 707730 705551	Riello F3 Riello BF5* Beckett AFG Beckett NX Carlin EZ	.55 x 60°A .50 x 60°A .60 x 70°B .60 x 60°B .60 x 60°W	105,000	91,000	79,000	526	85.5	3.6	300
		708840 708841	Carlin EZ Nat. Gas Carlin EZ LP Gas	Natural Gas LP Gas	90,000	76,000	66,000	440	85.0		
PROP3ES**	0.70	707719 707724 707740 707730 705551	Riello F3 Riello BF5* Beckett AFG Beckett NX Carlin EZ	.55 x 60°A .50 x 60°A .60 x 70°B .60 x 60°B .60 x 60°W	98,000	86,000	75,000	493	87.0 with 705813 Energy Star Kit**	3.6	300
PROP4	1.00	707721 707724 707741 707731 705551	Riello F5 Riello BF5* Beckett AFG Beckett NX Carlin EZ	.65 x 60°A .65 x 60°A .75 x 60°B .85 x 60°B .85 x 45°B	140,000	122,000	106,000	707	86.5	4.3	350
		708842 708843	Carlin EZ Nat. Gas Carlin EZ LP Gas	Natural Gas LP Gas	115,000	98,000	85,000	567	85.1		
PROP4ES**	0.95	707721 707724 707741 707731 705551	Riello F3 Riello BF5* Beckett AFG Beckett NX Carlin EZ	.65 x 60°A .65 x 60°A .75 x 60°B .75 x 60°B .85 x 45°B	133,000	116,000	101,000	673	87.0 with 705814 Energy Star Kit**	4.3	350
PROP5	1.25	707722 707724 707732 705551	Riello F5 Riello BF5* Beckett NX Carlin EZ	.85 x 60°A .85 x 60°A 1.00 x 60°B 1.00 x 60°B	175,000	153,000	133,000	887	86.9	5.1	390
		708844 708845	Carlin EZ Nat. Gas Carlin EZ LP Gas	Natural Gas LP Gas	150,000	127,000	110,000	733	85.1		
PROP5ES**	0.95	707722 707724 707732 705551	Riello F5 Riello BF5* Beckett NX Carlin EZ	.85 x 60°A .85 x 60°A .85 x 60°B .85 x 60°B	154,000	135,000	117,000	852	87.0 with 705815 Energy Star Kit**	5.1	390
PROP6	1.5	707723 707733 705551	Riello F5 Beckett NX Carlin EZ	1.00 x 60°A 1.25 x 45°B 1.25 x 45°B	210,000	184,000	160,000	1067	86.9	5.8	430
PROP7	1.75	707725 707734	Riello F10 Beckett CF 375	1.35 x 60°W 1.35 x 45°B	245,000	208,250	181,100	1207	85.0	6.5	470
PROP8	2.0	707725	Riello F10	1.65 x 45°B	280,000	240,000	208,000	1387	85.1	7.2	510

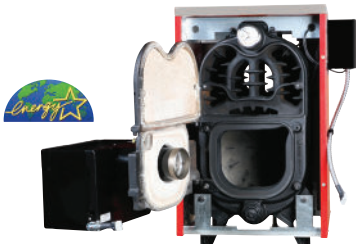

*Direct Vent Only: Models P3, P4, P5
**Energy Star rated

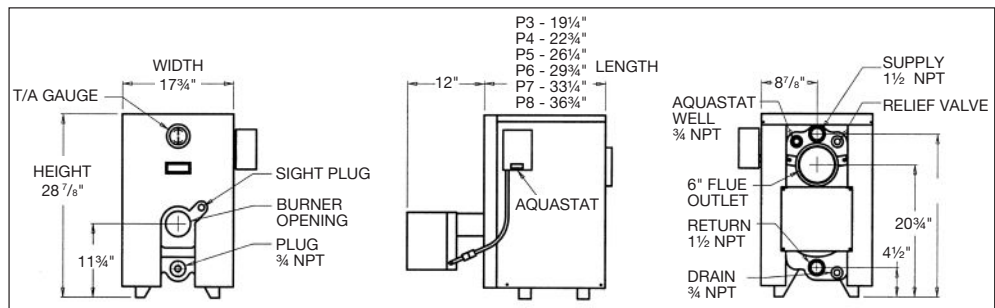

OPTIONAL COMPONENTS:

PurePro offers a complete line of 41- and 80- gallon indirect-fired water heaters to complement the TRIO boiler. Ask about the Plug 'n Go PLUS, the only pre-piped, pre-wired, packaged indirect water heaters in the industry!

P3, P4, & P5 BOILER BASE – Part # 707700

SYSTEM CIRCULATOR PACKAGE – Part # 707630

- For zone valve operation only
- Taco 007, includes flanges
- 9' long whip with Quick Connect feature when used with TRIO Energy Manager Plus II

3+1 EZ ZONE PAK – Part # 707640

5+1 EZ ZONE PAK – Part # 707650

Boiler Header System with 3 pre-installed zone valve bodies and an additional high flow port for an indirect water heater.

